

710r



COOPER Security

Scantronic

1

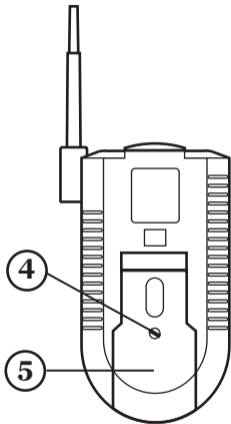
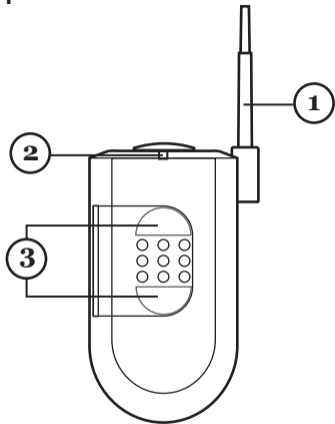

2

En

1. Aerial
2. Activity LED
3. Push buttons
4. Screw
5. Battery compartment cover

Nl

1. Antenne
2. Activiteit LED
3. Druktoetsen
4. Schroefje
5. Batterijhouder deksel

Fr

1. Antenne
2. LED d'activité
3. Touches
4. Vis
5. Capot du compartiment batterie

It

1. Antenna
2. LED di attività
3. Tasti

4. Vite
5. Coperchio del comparto batterie

Dk

1. Antenne
2. Aktivitets LED
3. Knapper
4. Skrue
5. Batteriholderen låget

Sv

1. Antenne
2. Aktivitets-LED
3. Knappar
4. Skruv
5. Batteriluckan

N

1. Antenn
2. Aktivitets LDC
3. Taster
4. Skruen
5. Batteriholderen lokket

De

1. Antenne
2. Aktivitäts-LED
3. Tasten
4. Schraube
5. Batteriefachdeckel

Es

1. Antena
2. LED de actividad
3. Tedas
4. Tornillo
5. Tapa del compartimiento de pilas

Pt

1. Antena
2. LED de Actividade
3. Tedas
4. Parafuso
5. Tampa do compartimento das pilhas

2

868.6625MHz, 20kHz



113mm

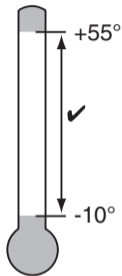
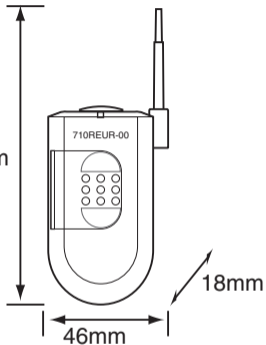

Security: EN510131 Grade 2

Environmental: Class II



3

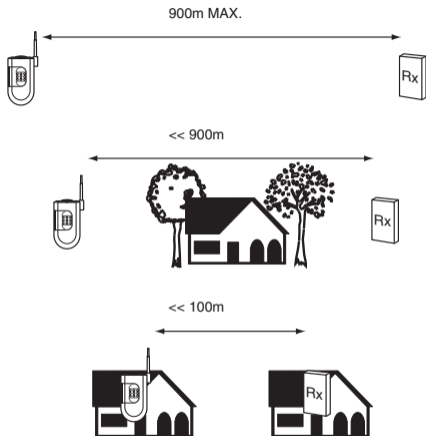

4

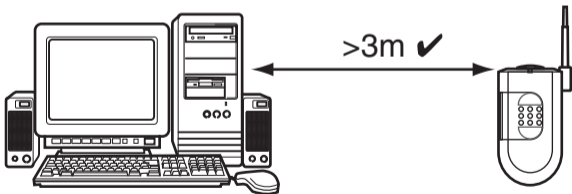
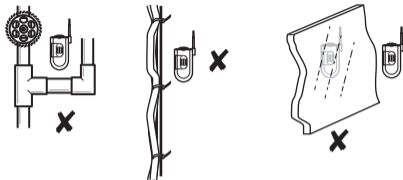

6

5

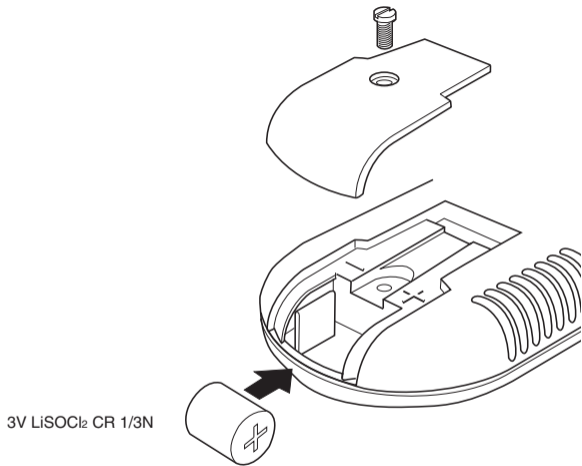

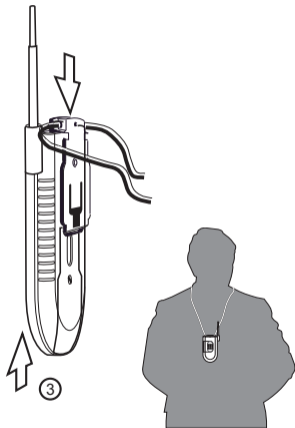
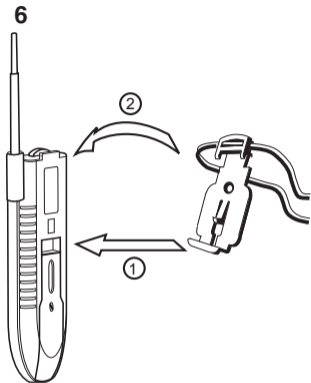

7

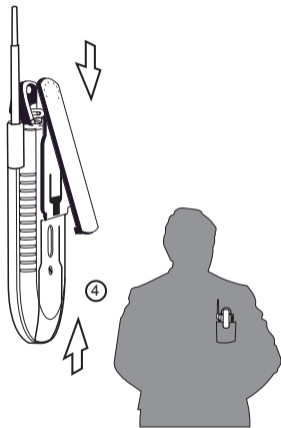
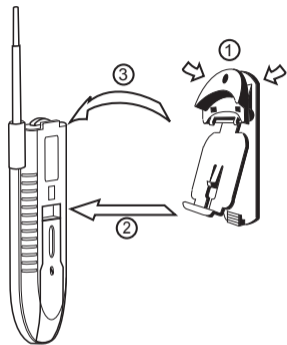

8

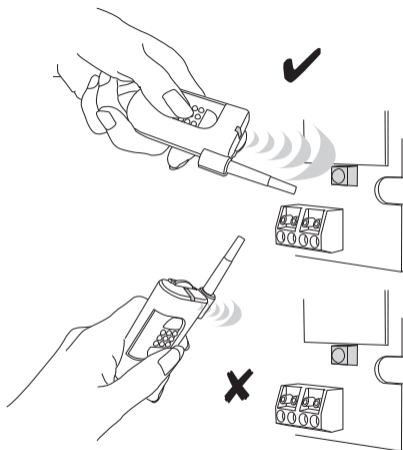

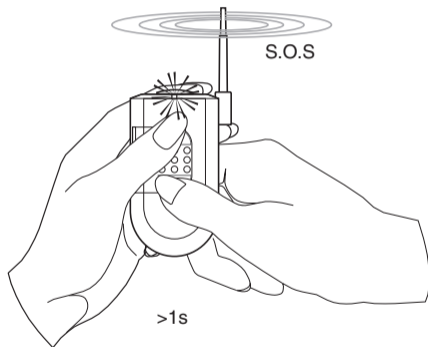

7500 ✓

7510 ✓

9960 ✓

RFX16 ✓

RFX08 ✓

762 ✓

768/769 ✓

10

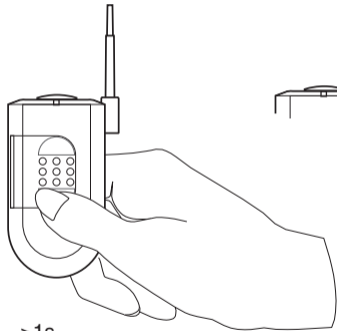

=



=



11

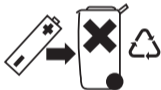

www.coopersecurity.co.uk

This product complies with the requirements of European Directive: **1995/5/EC** (Radio & Telecommunications Terminal Equipment Directive).

Dit product is conform de normen van de Europese Richtlijn 1995/5/EC (R&TTE Richtlijn)
Questo prodotto è conforme ai requisiti della Direttiva Europea: **1995/5/EC** (Radio & Telecommunications Terminal Equipment Directive).

Dette produkt er i overensstemmelse med kravene i EU-direktivet: **1995/5/EF** (Direktiv om radio- og teleterminaludstyr).

Dette produktet overholder kravene i EU-direktivet: **1995/5/EC** (Radio & Telecommunications Terminal Equipment Directive, R&TTE).

Den här produkten uppfyller kraven i EU-direktivet: **1995/5/EG** (direktivet för radioutrustning och teleterminalutrustning).

Dieses Produkt erfüllt die Anforderungen der europäischen Richtlinie **1995/5/EG** (Richtlinie für Funkanlagen und Telekommunikationsendeinrichtungen).

Este producto cumple con los requisitos de la Directiva Europea **1995/5/CE** (Directiva de equipo de terminal de radio y telecomunicaciones).

Este produto está conforme os requisitos da Directiva Europeia: **1995/5/CE** (Directiva sobre Equipamento de Radiocomunicações e Terminal de Telecomunicações).

Tämä tuote täyttää EU:n direktiivin **1995/5/EY** (Radio- ja telepäätelaitedirektiivi) asettamat vaatimukset.

For more information see: www.coopersecurity.co.uk.

© Cooper Security Limited 2006

Every effort has been made to ensure that the contents of this leaflet are correct . However, neither the authors nor Cooper Security Limited accept any liability for loss or damage caused or alleged to be caused directly or indirectly by this leaflet. The contents of this leaflet are subject to change without notice.

Printed and published in the U.K.

NL: Cooper Security Ltd
Terheydenseweg 465
4825 BK Breda
NEDERLAND

Tel: +31 (0)76 5729944
Fax: +31 (0)76 5729949
www.cooper-security.nl

Fr: Cooper Security
9-11 rue des Raverdis
92230 GENNEVILLIERS - France
Tél. : 01.41.11.32.90
Fax : 01.41.11.32.91

It: Cooper Security Limited
Via Meucci 10
20094 Corsico -MI-
ITALIA

TEL: +39 (0)2 45 86 73 96
FAX: +39 (0)2 45 01 509

Pt: Pretrónica-Precisão Electrónica, Lda.
Parque Industrial Serra das Minas
Av. Irene Lisboa, Lote 19, Armazém C, Piso 2
2635-001 Rio de Mouro
Portugal
Tel: +351 219 198 500
Fax: +351 219 198 501

ES: J.M. Systems-Com, S.L.
Ronda Isaac Peral, 9
Parc Tecnologic – Paterna
Valencia 46980
Telf. Serv. Técnico: 902 15 34 90
Lunes a jueves de 8:30 – 13:30 y 15:30 – 18:30
Viernes de 8:30 – 14:30
Fax: 96 131 81 42
E-mail: info@jmsystems.es
servicio.tecnico@jmsystems.es

UK: Cooper Security Ltd
Security House
Vantage Point Business Village
Mitcheldean
Gloucestershire
GL17 0SZ
Product Support (UK) Tel: +44 (0)870 757 5400
Available between:
08:15 and 17:00 Monday to Friday,
Product Support Fax: +44 (0)1594 545401

Part No. 11704539 Issue1
www.coopersecurity.co.uk